



































- EN PCD - Blanks and segments
- DE PKD - Ronden und Segmente
- FR PCD - Rondelles et segments
- IT PCD - Dischi e settori
- ES PCD - Sectores y segmentos

- EN PCD - Blanks and segments  
 DE PKD - Ronden und Segmente  
 FR PCD - Rondelles et segments  
 IT PCD - Dischi e settori  
 ES PCD - Sectores y segmentos

	<p>EN PCD-Grade chart            DE PKD-Sortentabelle            FR Tableau des nuances PCD            IT PCD-Tabella dei tipi            ES PCD-Tabla de calidades</p>	<b>184 - 185</b>
	<p>EN Standard and special PCD blanks            DE Standard- und Spezial-PKD-Ronden            FR Rondelles PCD standard et spéciales            IT Dischi standard e speciali in PCD            ES Rodajas PCD estándar y especiales</p>	<b>187- 188</b>
	<p>EN Sandwich PCD - half blanks            DE Sandwich-PKD - Halbronden            FR Demies rondelles sandwich PCD            IT Mezzidischi in Sandwich PCD            ES Semi-rodajas PCD en sandwich</p>	<b>189</b>
	<p>EN PCD segments            DE PKD-Segmente            FR Segments PCD            IT Settori in PCD            ES Segmentos PCD</p>	<b>190 - 191</b>

- EN PCD - Polycrystalline diamond - PCD grades and their applications  
 DE PKD - Polykristalliner Diamant - PKD-Sorten und ihre Anwendungen  
 FR PCD - Diamant policristallin - Les nuances de PCD et leurs applications  
 IT PCD - Diamante policristallino - I tipi di PCD e le loro applicazioni  
 ES PCD - Diamante policristalino - Calidades de PCD y sus aplicaciones

EN TIGRA grade DE TIGRA - Sorte FR Nuance TIGRA IT Tipo TIGRA ES Calidad TIGRA	Grain size Korngröße Grosseur du grain Groschezza del grano Tamaño del grano (µm)	Grain structure Kornstruktur Structure du grain Struttura del grano Estructura de grano (µm)	Binder type Binderart Type de liant Tipo legante Tipo de composición	Diamond content Diamantgehalt Teneur en diamant Contenuto di diamante Contenido de diamante	Toughness Zähigkeit Ténacité Tenacità Tenacidad	Bending strength Biegebruchfestigkeit Résistance à la flexion Resistenza flessionale Resistencia a la flexión	Abrasion resistance Verschleißfestigkeit Résistance à l'abrasion Resistenza all'abrasione Resistencia a la abrasión
<b>FS</b>	2 - 4		standard	standard			
<b>MS-W *</b>	8 - 10		standard	standard			
<b>MS</b>	8 - 10		standard	standard			
<b>MX</b>	8 - 10		special	reduced			
<b>MU+</b>	2 - 4 + 8 - 10		ultrahard	very high			
<b>CS</b>	20 - 35		standard	standard			
<b>CU+</b>	2 - 4 + 20 - 35		ultrahard	very high			

- \* EN Special for woodworking
- \* DE Speziell für die Holzbearbeitung
- \* FR Spéciale pour le travail du bois
- \* IT Speciale per la lavorazione del legno
- \* ES Especial para el trabajo de la madera

EN For technical data, please refer to page 7.  
 DE Die technischen Daten entnehmen Sie bitte der Seite 7.  
 FR Pour les données techniques, veuillez voir au page 7.

EN Roughing DE Schruppen FR Dégrossissage IT Sgrossatura ES Desbaste	Semi-finishing Semi-finischen FR Semi-finissage IT Semifinitura ES Semi-acabado	Finishing Finishen FR Finissage IT Finitura ES Acabado	Super-finishing Superfinishen FR Super-finissage IT Superfinitura ES Super-acabado	AI <6% Si	AI 6-12% Si	AI >12% Si	CFRP GFRP	Wood-based boards Platten auf Holzbasis Panneaux sur base de bois Pannelli a base di legno Tableros de madera-base	Comment Kommentar Commentaire Commento Comentario
○	✓	✓	✓	✓	○	■	■	○	EN Universal use, small grain DE Universeller Einsatz, kleines Korn FR Utilisation universelle, petit grain IT Uso universale, grano piccolo ES Uso universal, grano pequeño
✓	✓	✓	○	✓	✓	○	○	✓	EN Universal, economic, medium grain DE Universal, wirtschaftl., mittl. Korn FR Universel, éconóm., grain moyen IT Universale, econom., grano medio ES Universal, económ., grano medio
✓	✓	✓	○	✓	✓	○	○	✓	EN Universal use, medium grain DE Universeller Einsatz, mittl. Korn FR Utilisation universelle, grain moyen IT Uso universale, grano medio ES Uso universal, grano medio
✓	✓	✓	○	✓	✓	○	○	■	EN Best for medium % Si-AI DE Am besten für mittleren % Si-AI FR Le mieux pour un moyen % Si-AI IT Migliore per media % Si-AI ES Mejor para medio % Si-AI
✓	✓	✓	○	✓	✓	✓	✓	✓	EN MDF, laminate, universal, CFRP DE MDF, Laminat, universell, CFK FR MDF, stratifié, universel, CFRP IT MDF, laminato, universale, CFRP ES MDF, laminado, universal, CFRP
✓	✓	○	■	○	✓	✓	✓	✓	EN Universal use, coarse grain DE Universeller Einsatz, grobes Korn FR Utilisation universelle, gros grain IT Uso universale, grano grosso ES Uso universal, grano grueso
✓	✓	○	■	○	✓	✓	✓	✓	EN Best for CFRP DE Bestens für CFK FR Le mieux pour CFRP IT Migliore per CFRP ES Lo mejor para CFRP

- ✓ best performance
- ✓ very good performance
- acceptable
- not suitable

IT Per i dati tecnici, fare riferimento alla pagina 7.  
ES Para los datos técnicos, consulte la página 7.

- EN PCD - Further information
- DE PKD - Weitere Informationen
- FR PCD - Plus d'informations
- IT PCD - Ulteriori informazioni
- ES PCD - Más información

	EN Further information DE Weitere Informationen FR Plus d'informations	IT Ulteriori informazioni ES Más información
	EN For detailed technical information, please download from our homepage <a href="http://www.tigra.de">www.tigra.de</a> or ask for a printed copy of our technical guidebook "PCD for cutting tools".	
	DE Detaillierte technische Informationen finden Sie auf unserer Homepage <a href="http://www.tigra.de">www.tigra.de</a> zum download oder fordern Sie ein gedrucktes Exemplar unseres technischen Ratgebers "PKD für Schneidwerkzeuge" an.	
	FR Pour des informations techniques détaillées, s'il vous plaît télécharger à partir de notre page d'accueil <a href="http://www.tigra.de">www.tigra.de</a> ou demander une copie imprimée de notre guide technique "PCD pour les outils de coupe".	
	IT Potete scaricare le informazioni tecniche dettagliate dal nostro sito <a href="http://www.tigra.de">www.tigra.de</a> oppure richiedere una copia stampata della nostra guida tecnica "PCD per utensili da taglio".	
	ES Para obtener información técnica detallada, por favor descargue de nuestra página principal <a href="http://www.tigra.de">www.tigra.de</a> o solicitar una copia impresa de nuestro guía técnica "PCD para herramientas de corte".	

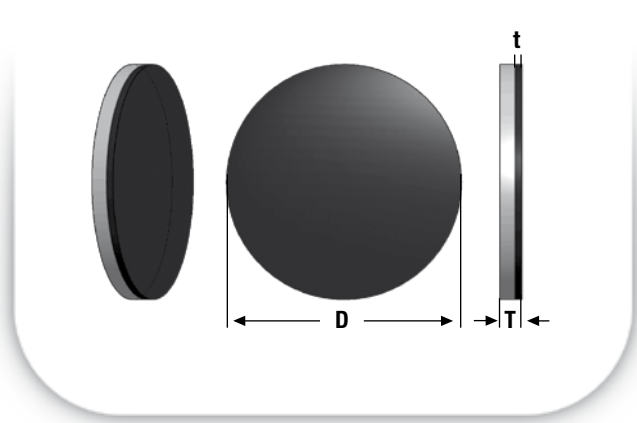

- EN Standard PCD blanks
- DE Standard-PKD-Ronden
- FR Rondelles PCD standards
- IT Dischi standard in PCD
- ES Rodajas PCD estándar

EN Grade DE Sorte FR Nuance IT Tipo ES Calidad	Properties and dimensions (mm)					Ø 62 mm Art.No.
	Grain size µm		Binder	T mm	t mm	
FS	Fine	2-4	Standard	1.6	0.5	141043
				2.0	0.5	141044
				3.2	0.5	141045
MS-W	Medium	8-10	Standard	1.6	0.5	142725
				2.0	0.5	142727
MS	Medium	8-10	Standard	1.6	0.5	139351
				2.0	0.5	139352
				3.2	0.5	141049
MX	Medium	8-10	Special	1.6	0.5	141050
				2.0	0.5	141051
				3.2	0.5	141052
MU+	Mixed	2-4 + 8-10	Ultrahard	1.6	0.5	139353
				2.0	0.5	139354
				3.2	0.5	141053
CS	Coarse	20-35	Standard	1.6	0.5	141054
				2.0	0.5	141055
				3.2	0.5	141056
CU+	Mixed	2-4 + 20-35	Ultrahard	1.6	0.5	141061
				2.0	0.5	141062
				3.2	0.5	141063

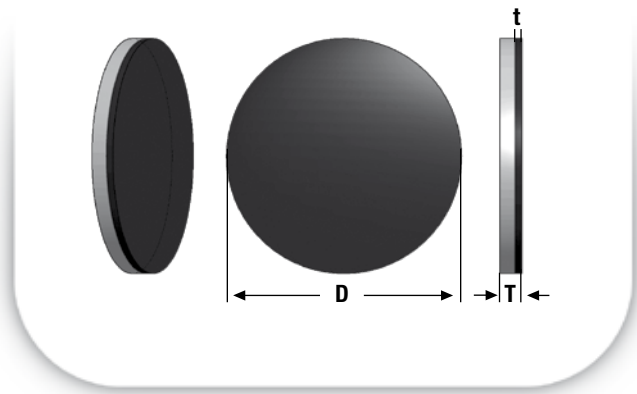

EN Special PCD blanks  
 DE Spezial-PKD-Ronden  
 FR Rondelles PCD spéciales  
 IT Dischi speciali in PCD  
 ES Rodajas PCD especiales

EN Grade DE Sorte FR Nuance IT Tipo ES Calidad	Properties and dimensions				Ø 62 mm	
	Grain size µm	Binder	T mm	t mm	Art.No.	
FS	Fine 2-4	Standard	1.0	0.3	141113	
			1.2	0.3	141114	
			1.6	0.3	141115	
MS	Medium 8-10	Standard	1.0	0.3	141117	
			1.2	0.3	141118	
			1.6	0.3	141119	
MX	Medium 8-10	Special	1.0	0.3	141120	
MU+	Mixed 2-4 + 8-10	Ultrahard	1.0	0.3	141121	
CS	Coarse 20-35	Standard	1.0	0.3	141122	
			1.2	0.3	141123	
			1.6	0.3	141124	
CU+	Mixed 2-4 + 20-35	Ultrahard	1.0	0.3	141126	

- EN Sandwich PCD - half blanks  
 DE Sandwich PKD - Halbronden  
 FR Demies rondelles PCD sandwich  
 IT Mezzidischi sandwich in PCD  
 ES Semi-rodajas PCD en sandwich

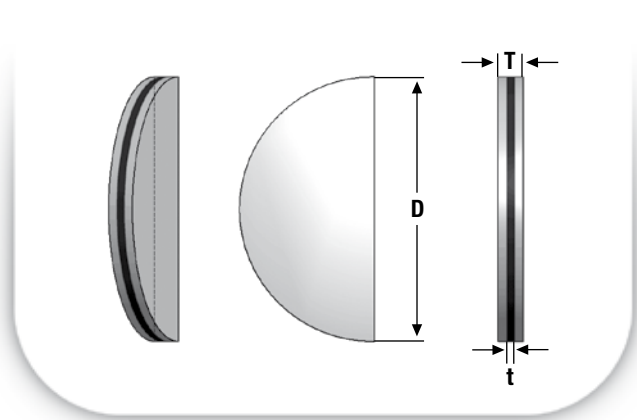

EN Grade DE Sorte FR Nuance IT Tipo ES Calidad	Properties and dimensions (mm)				Ø 62 mm Art.No.	
	Grain size µm	Binder	T mm	t mm		
<b>MX</b>	<b>Medium</b>	<b>8-10</b>	<b>Special</b>	1.5	0.5	<b>141064</b>
				2.0	0.8	<b>141065</b>
				2.5	1.0	<b>141127</b>
<b>MS</b>	<b>Medium</b>	<b>8-10</b>	<b>Standard</b>	1.5	0.5	<b>141066</b>
				2.0	0.8	<b>141067</b>
				2.5	1.0	<b>141128</b>
<b>CX</b>	<b>Coarse</b>	<b>20-35</b>	<b>Special</b>	1.5	0.5	<b>141068</b>
				2.0	0.8	<b>141069</b>
				2.5	1.0	<b>141129</b>





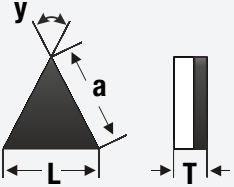
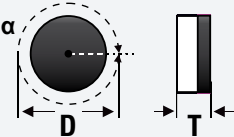
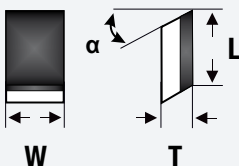

- EN Standard PCD segments  
 DE Standard PKD-Segmente  
 FR Segments PCD standards  
 IT Settori standard in PCD  
 ES Segmentos PCD estándar

EN Rectangle DE Rechteck FR Rectangle IT Rettangolo ES Rectángulo	
	<p style="text-align: right;"><b>RE L x W / T - Grade</b></p> <p><b>Example</b>      <b>RE 5.5 x 3.0 / 1.6 - MX</b></p>
EN Triangle DE Dreieck FR Triangle IT Triangolo ES Triángulo	
	<p style="text-align: right;"><b><math>\gamma</math> T a / T - Grade</b></p> <p><b>Example</b>      <b>60 T 5.0 / 1.6 - MX</b></p>
EN Round DE Rund FR Rond IT Rotondo ES Ronda	
	<p style="text-align: right;"><b><math>\alpha</math> R D / T - Grade</b></p> <p><b>Example full circle</b>      <b>360 R 20.0 / 1.6 - MX</b></p> <p><b>Example half circle</b>      <b>180 R 22.4 / 1.6 - MX</b></p>
EN With angle DE Mit Winkel FR Avec angle IT Con angolo ES Con ángulo	
	<p style="text-align: right;"><b>RE L x W / <math>\alpha</math> / T - Grade</b></p> <p><b>Example</b>      <b>RE 4 x 3 / 24° / 1.6 - MX</b></p>



- EN Cutting service  
DE Schneiddienst  
FR Service de coupe  
IT Servizio di taglio  
ES Servicio de corte

**EN** TIGRA offers you a quick service for laser-cut PCD: according to your drawing, we cut within 3-5 working days, with and without angle. The segments are delivered cleaned and packaged safely. Thanks to the efficient production planning and processing, our laser-cut segments are in many cases significantly less expensive than whatever is possible by wire cutting!

**DE** TIGRA bietet Ihnen einen Schnellservice für Laser geschnittenes PKD: nach Ihrer Zeichnung trennen wir innerhalb von 3-5 Arbeitstagen, mit und ohne Winkel. Die Segmente werden gereinigt und sicher verpackt ausgeliefert. Dank der effizienten Arbeitsvorbereitung und Bearbeitung sind unsere Laser geschnittenen Segmente in vielen Fällen deutlich günstiger als dies mit Drahtschneiden möglich ist!

**FR** TIGRA vous offre un service express pour PCD découpé au laser. Nous découpons avec ou sans angle et suivant votre dessin dans un délai de 3-5 jours ouvrables. Les segments sont nettoyés et livrés solidement emballés. Nos segments découpés au laser sont dans de nombreux cas nettement plus avantageux que par découpe par fil grâce à la préparation du travail et à l'usinage efficaces!

**IT** TIGRA vi offre un servizio rapido per PCD tagliato a laser: in base ai vostri disegni, eseguiamo i tagli entro 3-5 giorni lavorativi, con e senza angoli. I settori vengono puliti e spediti in imballi sicuri. Grazie all'efficienza di preparazione e lavorazione, i nostri settori tagliati a laser sono spesso più economici di quelli ottenuti con una macchina ad elettroerosione!

**ES** TIGRA ofrece un servicio rápido de corte por láser para calidades PCD: en un plazo de 3-5 días realizamos trabajos a medida, con o sin ángulo, conforme a su diseño. Los segmentos se entregan en embalaje seguro y limpios. Gracias a una eficiente preparación del trabajo y un óptimo mecanizado nuestros segmentos cortados por láser son en muchos casos sustancialmente más económicos que los de corte por hilo.